



Installation Manual

TerraGen Environmental Group

120 Parson Rd.

Alliston, Ontario, L9R 1E9

705-435-7373

Version: 13/11/2023

Table of Contents

1.	General.....	2
2.	Material Receiving	2
3.	Tools.....	3
4.	System Components	4
5.	Annual Maintenance Activities	5
6.	Installation of System	6
6.1	Prep Work & Pre-assembly	6
6.1.1	Tilt Assembly Installation.....	6
6.1.2	Cutting Rails	6
6.2	Bottom Rail Installation	7
6.2.1	Attachment Layout	7
6.2.2	Bottom Rail Layout	7
6.2.3	Bottom Rail Splicing.....	7
6.3	Top Rail Installation	8
6.3.1	Cross Adapter Setup	8
6.3.2	Top Rail Layout	9
6.3.3	Top Rail Splicing	10
6.3.4	Top Rail Thermal Breaks	10
6.4	Home Run Wiring.....	10
6.6	Module Installation	11
	Appendix A: Bonding & Grounding.....	12
	Appendix B: Installation Efficiencies	13
	Appendix C: Wire Management Options.....	14
	Appendix D: MLPE Mounting.....	15
	Appendix E: Bonding & Grounding With No Bottom Rail.....	16

1. General

The TGT System is designed to be installed on a sloped roof for an array of any size, provided the guidelines within this manual and any other applicable codes and standards are followed.

It is a rail-based design intended to secure 2-8 modules per rail, with continuity through splicing to create a grid-system. The system can be installed in landscape or portrait orientation for PV modules up to 45" X 90", provided the project specific design has been done accordingly and the module manufacturer guidelines are followed.

To ensure proper installation and prevent a void of your warranty, the installation manual and the project specific documentation must be followed.

In unique or custom cases where alternative components or design is required, the project specific documentation will supersede the installation manual where there is insufficient or conflicting information.

2. Material Receiving

A detailed bill of lading will be sent with the shipment of racking. The receiver must confirm that all parts received are according to the detailed Bill of Lading and Packing Slip. Any damage must be noted on the bill of lading upon receipt. Any discrepancies must be reported within 2 business days. Otherwise, all claims will be invalid. If there are any damaged parts or rails, please provide a picture as well as documenting it on the Bill of Lading.

3. Tools

Tools:

1. Drill with torque limiter OR torque wrench
2. 13mm deep socket
3. 13mm combination wrench

NOTE: Accessories may require additional tools

Torque Settings Required:







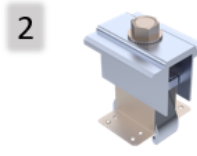
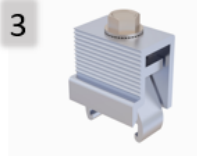

12 ft-lbs (16 N-m): Cross adapter, end clamp, mid clamp, angle brackets

Miscellaneous:

1. Onsite cutting availability
2. Measuring tape
3. Paint marker (for torque marking)
4. String and/or spray paint (for alignment)

- **Use of impact tools when installing clamps and hardware will cause galling (seizing of SS hardware). TerraGen will not free issue components damaged from use of impact tools.**
- **All fasteners must be torque marked after applying the required torque.**

4. System Components

1 	2 	3 	4 
End Clamp	Mid Clamp w/Bonding Washer	Cross Adapter	Top Rail
5 	6 	7 	8 
Splice 1966 (Bonding Integrated)	Tilt Assembly (Pre-Assembled)	Angle Bracket & T-Bolt (M8) & Nut	Small Angle Bracket & T-Bolt (M8) & Nut
9 	10 		
Hex Bolt (M8x50) & Nut	T-Bolt (M8) & Nut (upon request for MLPE)		

TGT System

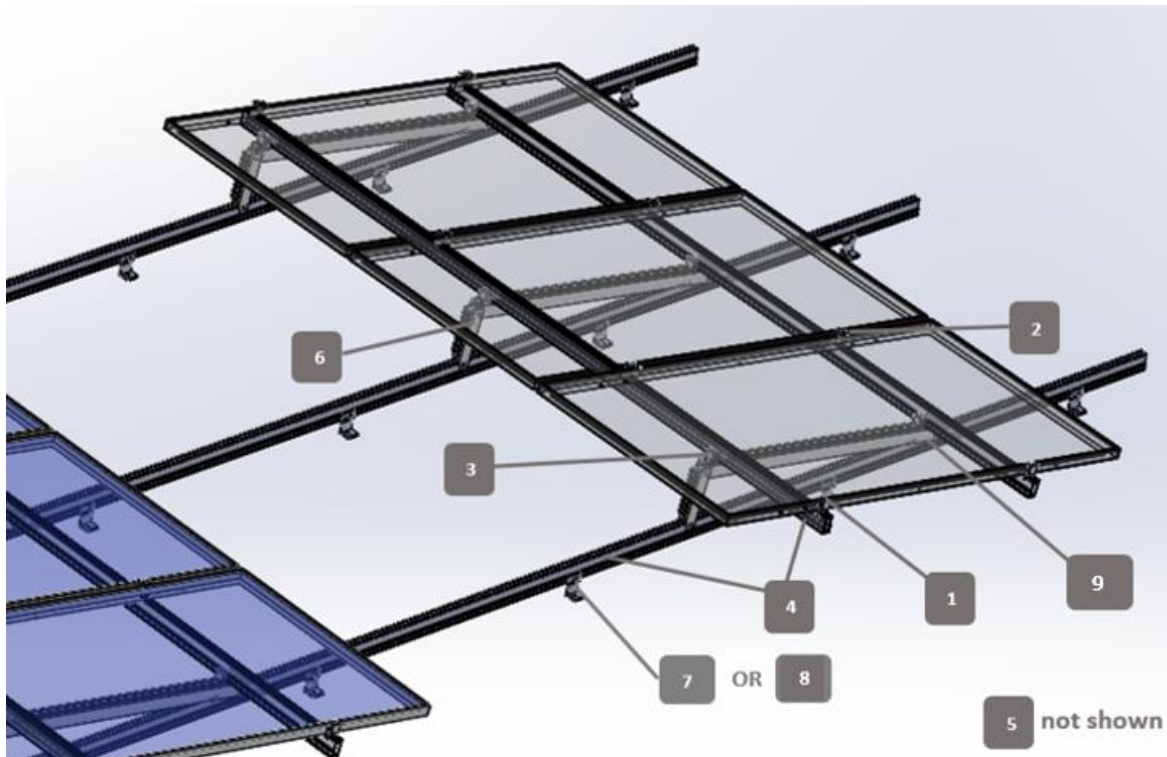

5. Annual Maintenance Activities

The activities described below for the maintenance of the solar racking provided by TerraGen must be performed a minimum of every 12 months from the date of installation up until the system has been decommissioned. Records with images of the inspection must be recorded and kept.

- Perform a visual inspection of the system to check all components for any signs of defect. Any components showing signs of damage that compromise safety shall be replaced immediately.
 - Check for any deformation, penetrating corrosion, or other noticeable defects in the components.
 - Inspect roofing condition around the contact points with the roof and that the system has not moved over time. Ensure appropriate roof protection is still secured appropriately in place.
 - Modules are seated correctly and secured.
- Check all hardware for specified torque or torque marks. Any loose components or fasteners shall be re-tightened in accordance with the installation instructions.

6. Installation of System

6.1 Prep Work & Pre-assembly

6.1.1 Tilt Assembly Installation

Assemble the tilt assemblies onto the base rails using the M8 - 50 mm bolt through the pre-punched holes and securing with the M8 serrated nut. This hardware is to be torqued to 8ft-lbs.

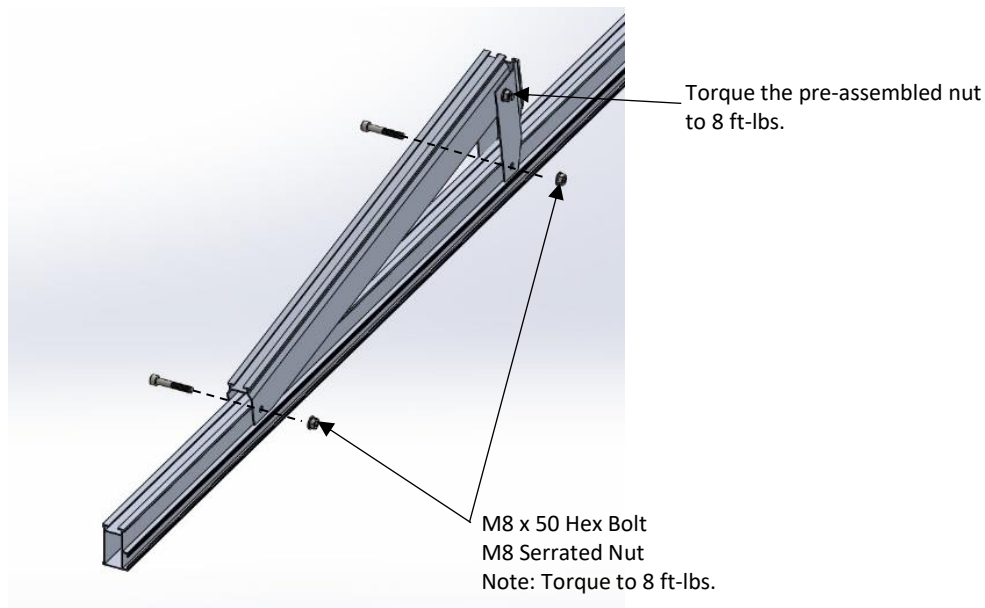

A is where tilt assemblies are placed. B is space between tilt assemblies. $S + N = B$ in most cases. N and S represent the amount of base rail left over at the North end and South end, respectively.



Base Rail Side View

6.1.2 Cutting Rails

Please refer to the Construction Package for the cuts required for the project, it is advantageous to set up a cutting station to prep all of these before installation.

6.2 Bottom Rail Installation

6.2.1 Attachment Layout

Refer to the construction package for the method and locations of the roof attachments.

6.2.2 Bottom Rail Layout

Locate the starting point for the first bottom rail according to the Construction Package. The remainder of the bottom rails can be located in reference to the starting bottom rail with proper center to center spacing from the Construction Package, by measuring or using a spacing jig. No additional measurements are absolutely required to align the front and back base rails, though a string or laser line can be helpful.

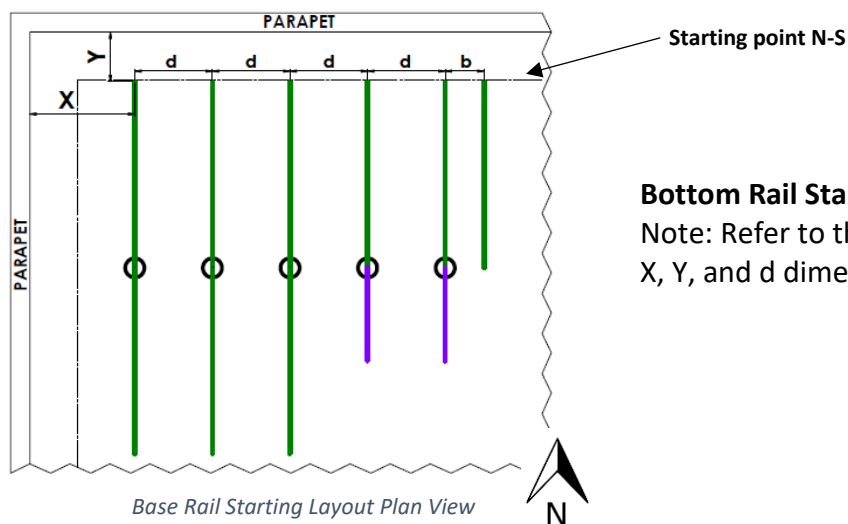

Bottom Rail Starting Layout Plan View

Note: Refer to the Construction Package for X, Y, and d dimensions.

6.2.3 Bottom Rail Splicing

When required, the bottom rails get spliced together with a bonding integrated splice bar. Ensure that the bottom rail is stopped by screw head and that the bonding clip is engaged with the aluminum from both rails. Where thermal breaks are required, a $\frac{3}{4}$ " gap must be maintained between the ends of the top rails.

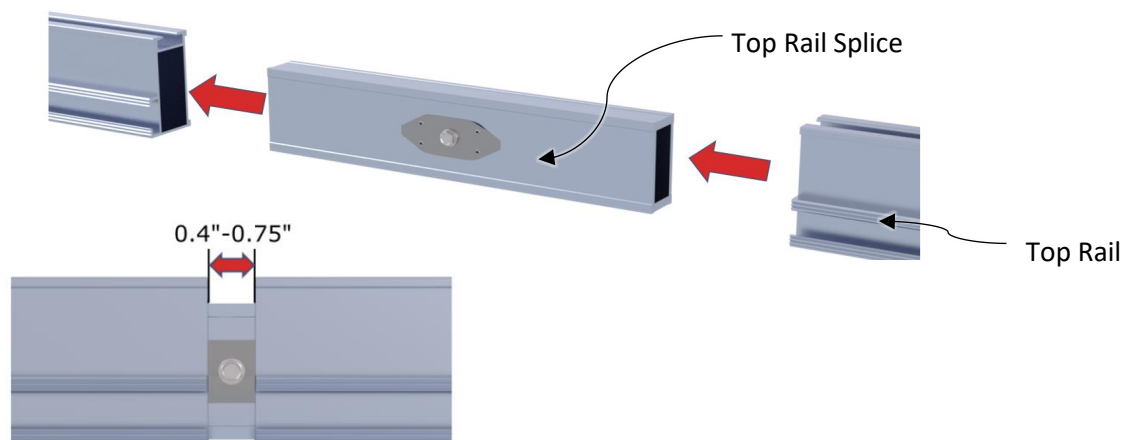

6.3 Top Rail Installation

6.3.1 Cross Adapter Setup

Use cross adapters to secure the top rails to the tilt assemblies. Click the cross adapter onto the tilt assembly to attach a top rail. Once both cross-adapters are installed on both sides of the top rail, torque to 12 ft-lbs. Two cross adapters per connection are required on all connections in the field. Refer to the figure below for a visual of the installation method.

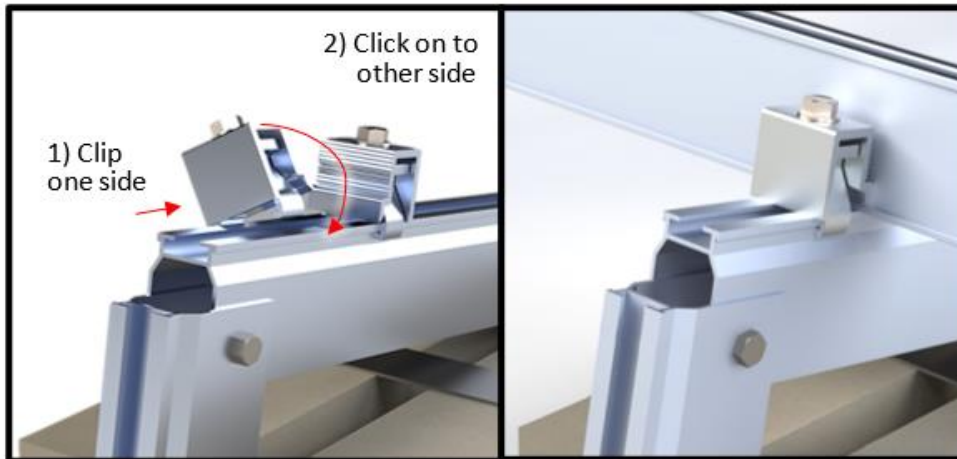

The figure below illustrates how to determine the location of the cross adapters.

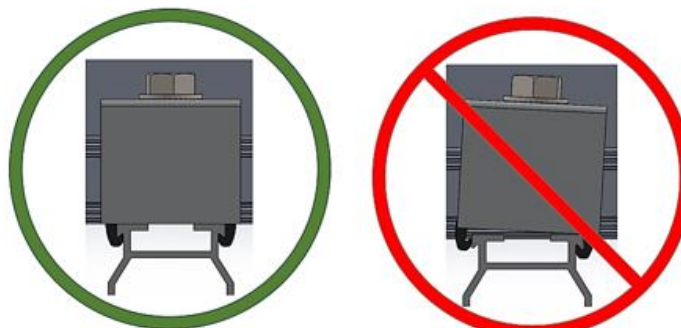
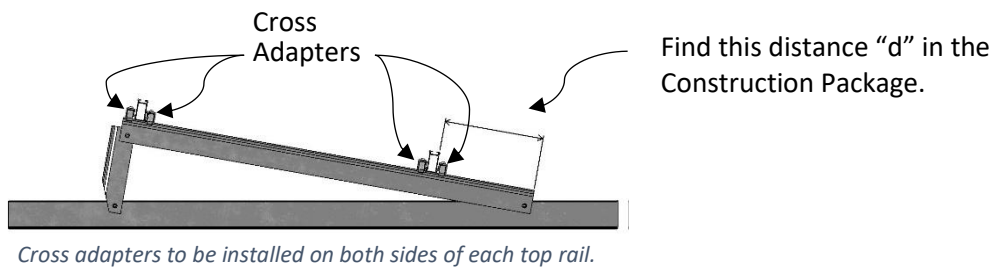

CORRECT - BOTH SIDES ENGAGED

INCORRECT - NOT ENGAGED / ANGLED

 MOVE CLAMP SIDE TO SIDE TO ENSURE CLAMP CLICKS IN PLACE

6.3.2 Top Rail Layout

Top rails should be installed in the locations specified by the top rail layout plan. The layout plan can be found in the Construction Package. Please refer to it for top rail cut lengths and positions.

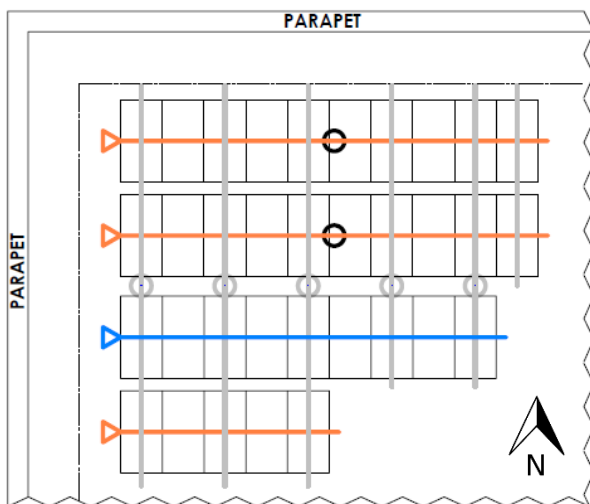

Top Rail Starting Layout Plan

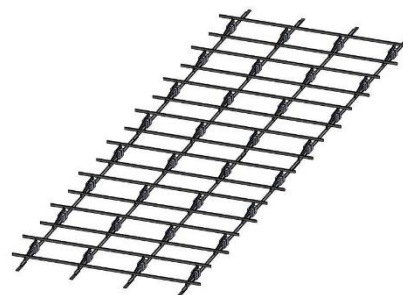

The maximum overhang amount is also specified in the construction package and it is measured from the edge of the mounted panel to the base rail. A minimum of 2" of top rail is required past the end of the module on the starting side.

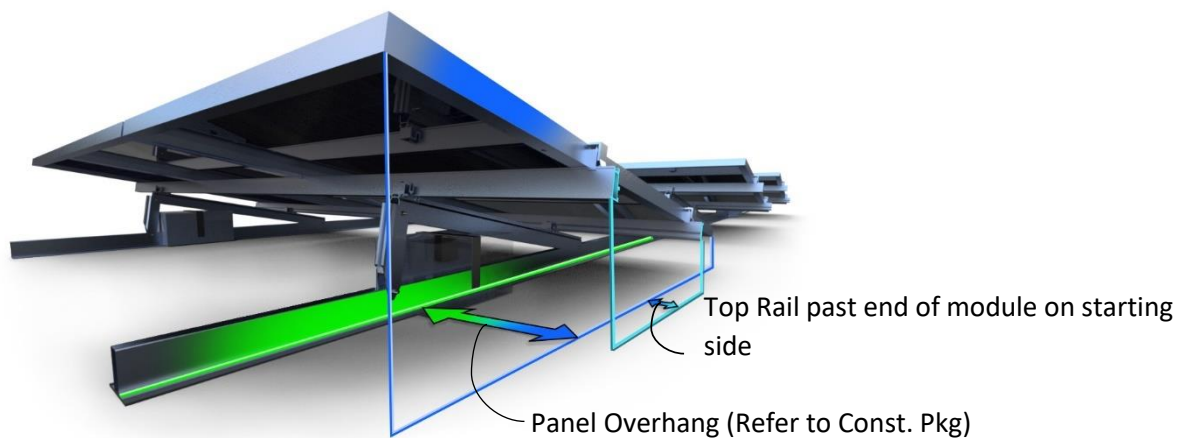

6.3.3 Top Rail Splicing

When required, the top rails get spliced together with a bonding integrated splice bar. Ensure that the top rail is stopped by screw head and that the bonding clip is engaged with the aluminum from both rails. Where thermal breaks are required, a $\frac{3}{4}$ " gap must be maintained between the ends of the top rails.

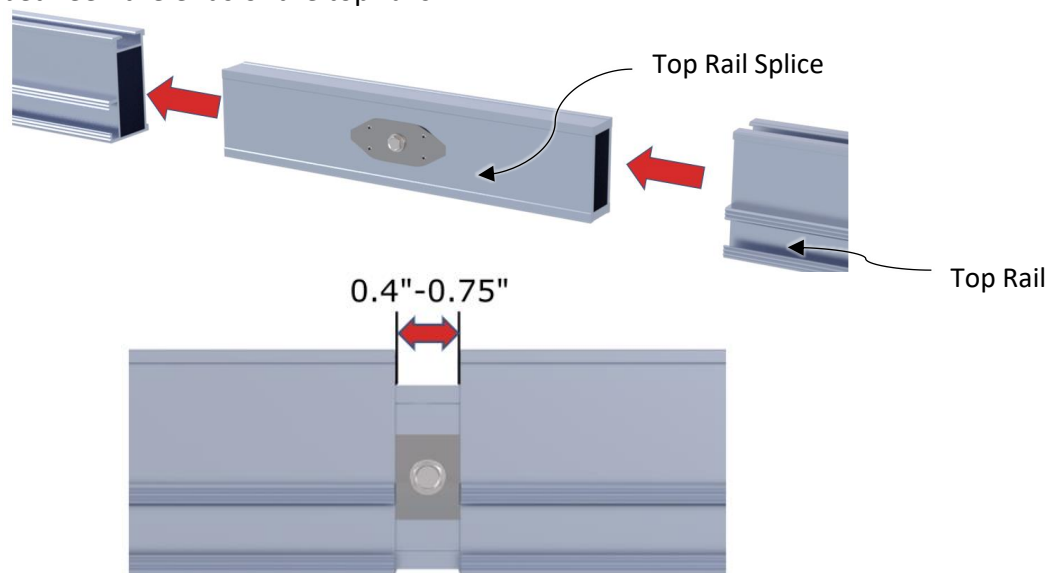

6.3.4 Top Rail Thermal Breaks

In the case of extended rows, where a thermal break is required (refer to Construction Package), a module break is required divided by two end-clamps and a splice.

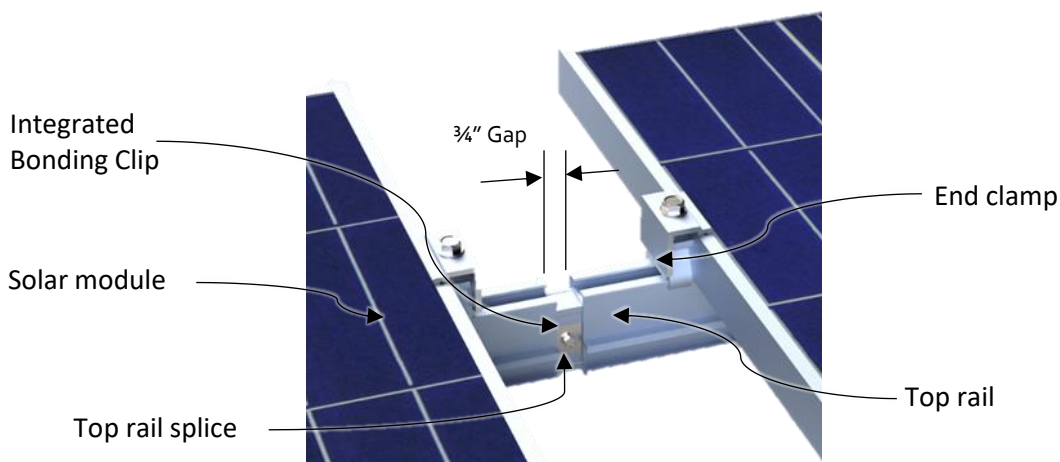

6.4 Home Run Wiring

After top rail installation is complete, this would be the best time to run all PV cable and home runs as this allows the installer to have free range of access to the racking for securing the PV cable.

6.6 Module Installation

Install the modules by first clicking the end clamps onto the end of the top rails. Adjust the module to the proper position and torque the end clamp bolt between 12 and 14 ft-lbs, **only exceeding 12 ft-lbs if necessary to ensure clamp sits flat on module frame**. Next, click the mid clamps and bonding washer onto the top rail (refer to *Appendix B*).

Slide the mid-clamp in tight to the module making sure that the tab of the bonding washer is placed under the module frame. Once the next module is placed properly, the mid clamp can then be secured, and the bolt torqued to 12 ft-lbs.

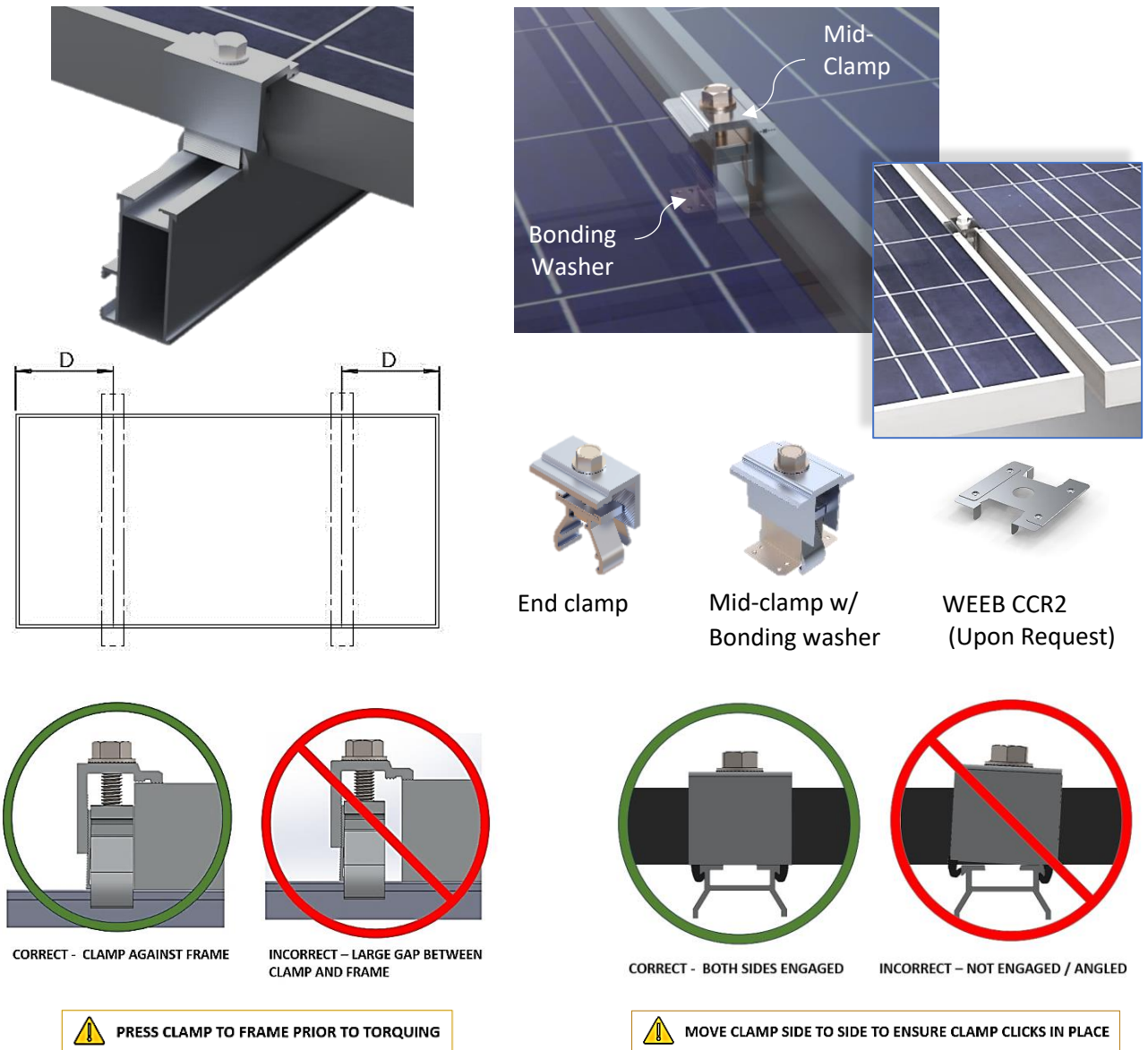

See construction package for details on clamp zones. TerraGen makes every attempt to ensure that the module clamping zones of the module manufacturer are met. However, ultimately it is the responsibility of the customer to verify that the module warranty will be maintained.

Appendix A: Bonding & Grounding

The system has been evaluated/certified for Grounding/Bonding, and conforms to UL 2703. Refer to 'Module Listings' document for modules that have been certified to LTR AE-001-2012 and UL 2703.

Connection 1: Module to Top Rail

Mid-clamps with bonding washers bond rails to module frames with teeth piercing the anodized surface of the module.



Connection 2: Top Rail to Top Rail

In cases where two or more rails may need to be spliced together, top rails are spliced through a sliding splice which consists of a bonding clip that pierces the surface of the aluminum rails.

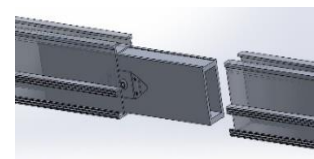

Connection 3: Top Rail to Tilt Assembly

Top rails are connected to tilt assemblies using cross adapters.



Connection 4: Tilt Assembly to Bottom Rail

Tilt assemblies connect onto the base rails using the M8 - 50 mm bolt through the pre-drilled holes and secured with the M8 serrated nut.

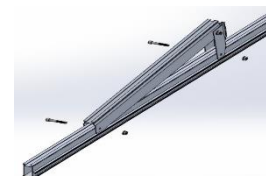

Connection 5: Bottom Rail to Bottom Rail

In cases where two or more rails may need to be spliced together, bottom rails are spliced through a sliding splice which consists of a bonding clip that pierces the surface of the aluminum rails.

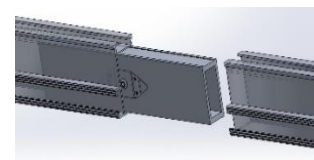

Connection 6: Grounding Each Array

IlSCO SGB-4 or other UL 467 listed Grounding Device (supplied by others) is used to ground the system. Provided the previously mentioned connections all apply; each individual array only needs to be grounded once (though 2 locations are suggested). Location for grounding device is often the back leg of the tilt assemblies or the excess end of a top rail.

Appendix B: Installation Efficiencies

Pre-Assembly of Tilt Assemblies on Base Rails

If a holding rack is available, such as the one shown in the photo below, you may choose to use this method to speed up the assembly process.



Telescopic Handler hoisting a holding rack with assembled bottom rails.

Prior to hoisting the skid of tilt assemblies and the bundle of bottom rails to the roof of your building, take time to pre-assemble the tilt assemblies onto the bottom rail while still on the ground. Using sawhorses to hold the work piece at waist height, cut all necessary lengths. Refer to your Construction Package for lengths of base rails.

Once cut, place tilt assemblies onto the entire length, lining them up to the holes. Use the M8 bolt and serrated nut to fasten the tilt assembly in place. Torque to 8 ft-lbs. Place on holding rack. Ensure that the bundle is adequately secured to the holding rack for hoisting to the roof.

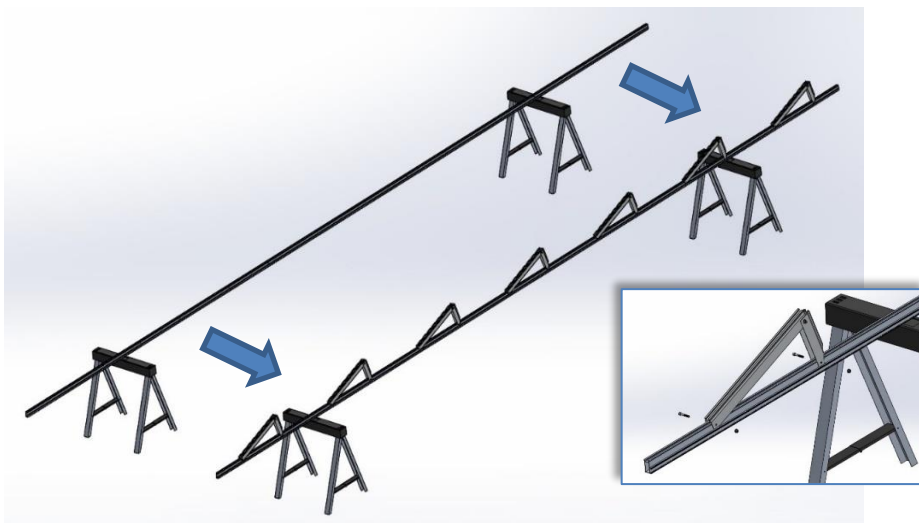



Appendix C: Wire Management Options



PHOTO #1: East West rails can be used to secure PV wire. In this image, the installer has used PVC straps secure on the rail to support the PV wire.

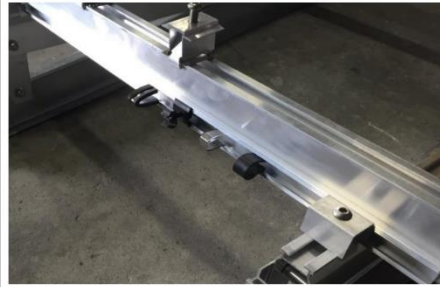

PHOTO #2: Another option for securing the PV wire to the east west rails is the optional wire management clips that TerraGen offers.



PHOTO #3: PV wire management using the optional wire management clips on the solar panel.



PHOTO #4: TGR base rails, (the north south rails) can be used to secure wires requiring management from row to row. We permit installers to secure wire management components to our base rail. In this case the installer used PVC conduit.



PHOTO #5: Row to row DC wiring can be pulled through PVC conduit attached to the base rail and split loom wire protection.



PHOTO #6: TGR base rails can be used to support cable tray for wire support running from West to East.

Appendix D: MLPE Mounting

T-Bolt assembly is available upon request from TerraGen to mount MLPE (microinverter or optimizer) into the channel of TerraGen rails. Ensure that guidelines from the MLPE installation manual are followed.



Appendix E: Bonding & Grounding With No Bottom Rail

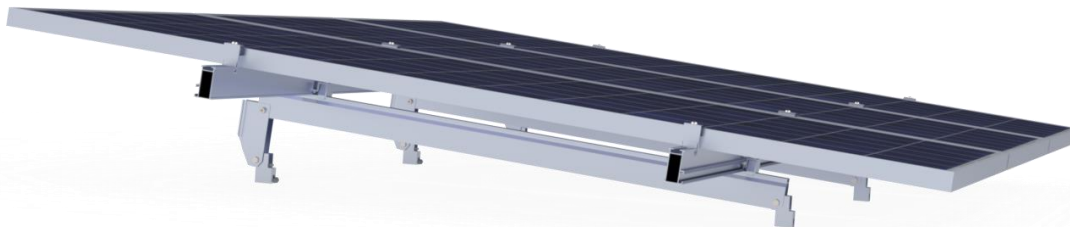

The system has been evaluated/certified for Grounding/Bonding and conforms to UL 2703. Refer to 'Module Listings' document for modules that have been certified to LTR AE-001-2012 and UL 2703.

Connection 1: Module to Top Rail

Mid-clamps with bonding washers bond rails to module frames with teeth piercing the anodized surface of the module.

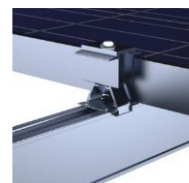

Connection 2: Top Rail to Top Rail

In cases where two or more rails may need to be spliced together, top rails are spliced through a sliding splice which consists of a bonding clip that pierces the surface of the aluminum rails.

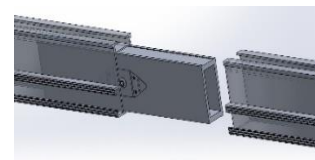

Connection 3: Grounding Each Row

IlSCO SGB-4 or other UL 467 listed Grounding Device (supplied by others) is used to ground the system. Provided the previously mentioned connections all apply; each individual row needs to be grounded once. Location for grounding device is often the excess end of a top rail.